

PERISTALTIC PUMPS

2022 | 1

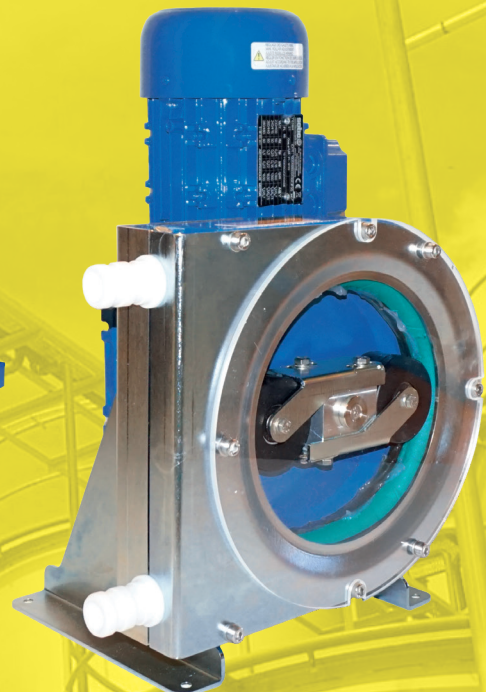
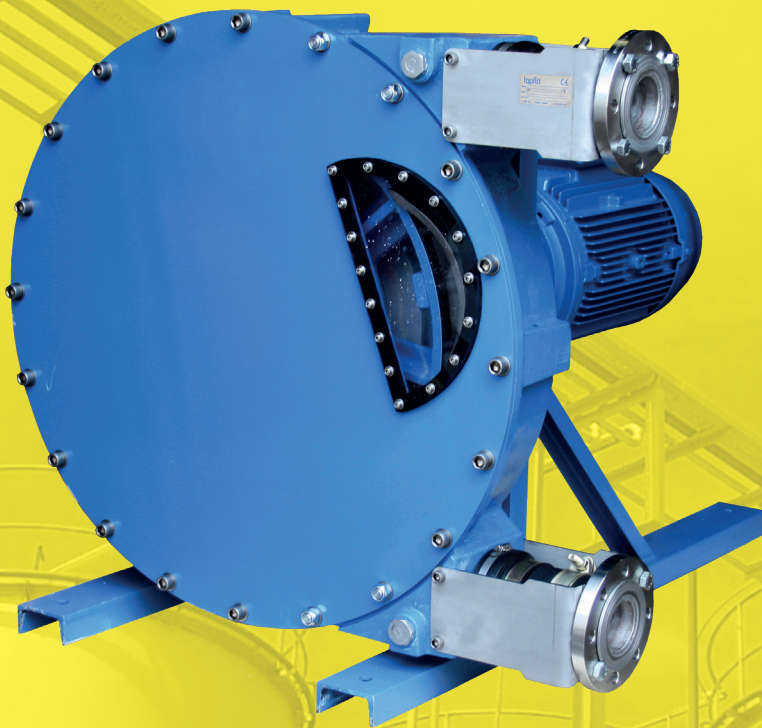

» All about your flow™

We began our journey 40 years ago in Kungälv, a small town on the Swedish west coast, as a family company with an ambition to one day become a global player on the pump market.

Since 1980, we have taken pride in delivering a wealth of knowledge and passion for pumps to the industry, whilst supplying a wide range of premium products for various industrial applications.

Over the years, the company has developed into a global Tapflo Group with branches and distributors present in nearly every region of the world.

One thing did not change - we are still a family company.

Our solutions are designed and manufactured in Europe and distributed globally to offer the best service and flow solutions to our customers for a variety of applications.

Our values, Commitment, Quality and Simplicity are reflected both in our product and business approach.



For fast and flexible service and high-quality products readily available worldwide, choose Tapflo.

Quality commitment

At Tapflo we are simply committed to quality. As a result, our production standards, as well as products quality, comply with various globally recognised certification and quality control standards. The Tapflo manufacturing process is certified according to ISO 9001:2015, confirming that our processes are appropriate, effective, customer-focused and continuously improved.



Tapflo values

Our culture is concluded in Our values

Commitment

We are different from our competitors because of our willingness to exceed the customers' expectations, move fast and be flexible. Our culture is based on the spirit of togetherness, enthusiasm and integrity. We come from all over the world but we share the same values and we respect each other. We are committed.

Quality

We understand that the quality in our work is never better than the weakest link, that's why we focus on every small detail. We share a common passion for continuously finding more efficient and effective ways to provide value to our customers. As a manufacturer we have control of the complete process both in terms of our products and the way we operate internally. That is why we manufacture the highest quality pumps in our segment.

Simplicity

We have a saying, "Simple is art" which means we try to find smooth and uncomplicated solutions in everything. By keeping it simple we can focus on the essential, like designing uncomplicated pumps with few components. For us it is a key to success; strive to simplify what is complex.

PTL series

Typical applications



Pharmaceutical industry

chemical dosing, liquid protein, vaccines, serum, plasma, syrups



Water treatment

sodium hypochlorite, ferric chloride, sodium bisulfite, fluoride, polymers, aqueous ammonia, potassium permanganate, caustic soda, and many more



Pasta, cheese industry

egg white & yolk, edible fat, semolina, natural flavoring, cream, milk and yogurt

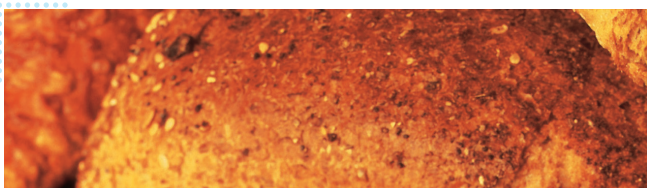

Bread dough & fruit cake

water & salt mixtures, natural flavorings, fats, fruit cake dough/mixture (i.e. fruit cake has nuts and fruit pieces that need to stay whole)

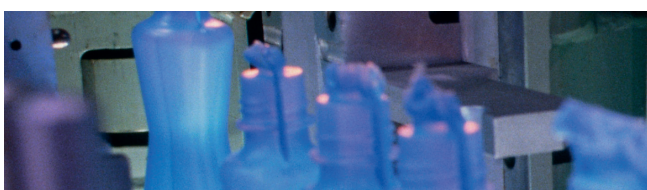

Cosmetics industry

shampoo, liquid soap, shower gel, lotion,

PT series

Typical applications



Industry

various acids, PVDF latex, alcohol, soap, non aromatic solvents, sludge with viscosity up to 60 000 Cps, clay up to 800g/l, particle size: 30 mm, lead sulfate, pyrite, SABX, cyanide, various acids

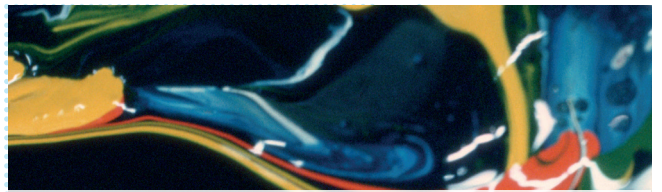

Paint

water based paint, acrylics, pigments, ink, wall coating



Water treatment

lime cream, ferrous chloride, activated carbon, reagent feed, coagulant, flocculate dispersion, alum, sludge and foams

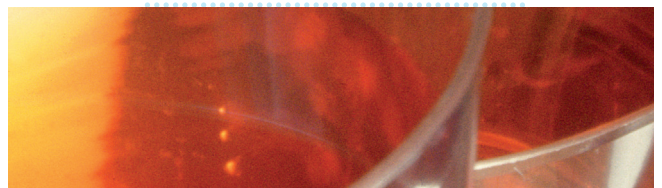

Food industry

tomato sauce, mash potatoes, gelatin, beer yeast, fish paste, olive oil, wine, PAINT water based paint, acrylics, pigments, ink, wall coating



Paper mills

latex, kaolin, paper waste sludge, various chemical dosing

■ Working principle

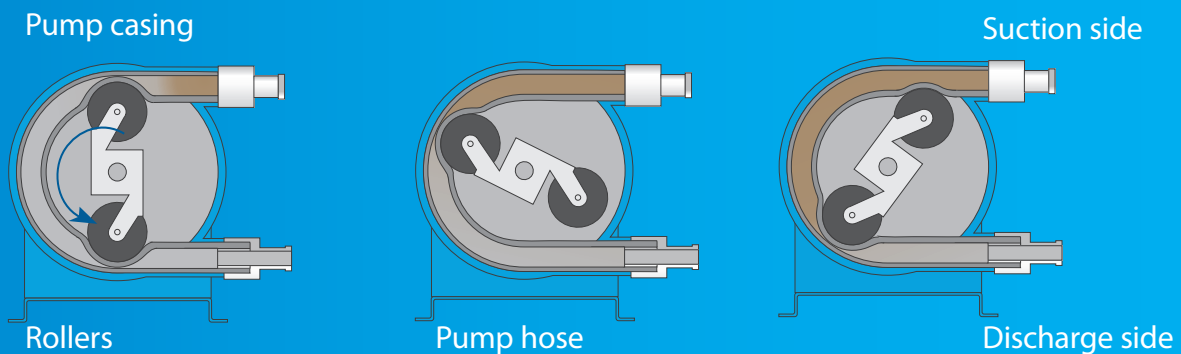

Two rollers* mounted at 180° on a rotor compress alternatively a thick-walled hose in a patented concentric guide and push the pumped liquid from the suction to the discharge side. Roller movement compresses the hose along the casing wall and creates constant vacuum at the suction side of the pump. In this way, liquids are conveyed within the hose and do not get in contact with any metal part.

* PT series is equipped with shoes instead of rollers

Roller design (PTL) vs Shoe Design (PT)

The roller design in PTL pumps has been proven to be successful in the lower pressure applications until 4 bars, since lubrication is not really necessary between hose and roller and the radial force are very low allowing the rotation. To protect the hose, the roller operate in grease.

For higher pressures until 15 bars, from approximate 4 bar, the rollers do not rotate anymore and the angle at the point of compression becomes fairly steep, which acts negatively on the hose. In this case, the shoe design of PT pumps has been proven to be more efficient, since they act more gentle on the hose.

To protect the hose, the shoes operate in a bath of lubricant. Depending on the application, different oil types or glycerin based can be used.

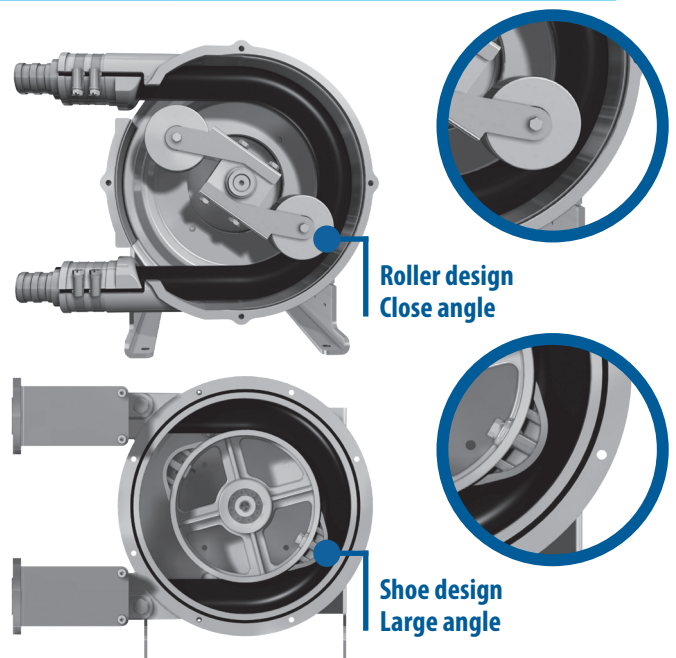

Features & Benefits

- ✓ **Seal-less design**
 No mechanical seal or stuffing box and other rotating equipment in media that can cause leakage.
- ✓ **Lowest cost of ownership and quick and easy maintenance**
 Tapflo pumps contain the fluid in a hose, requiring only one component to be changed, which means that maintenance costs are considerably lower than other pump types.
- ✓ **Reversible flow**
 Easy emptying and draining.
- ✓ **Low sound level:**
 Below < 70 dB at 1 meter.
- ✓ **Self-priming and continuous dry running**
 Tapflo pumps can self-prime up to 9.8 metres and run dry indefinitely.
- ✓ **Accurate and repeatable dosing and metering**
 Tapflo pumps are accurate up to $\pm 0.5\%$ across their total speed range, with the additional benefit of process control capabilities which allows easy installation.
- ✓ **Long life and greater reliability**
 The PTL & PT range is designed and manufactured for heavy duty industrial use, and advanced elastomer technology ensuring accurate and repeatable performance that truly outperforms all other pumps.

PTL series

Low pressure hose pumps

Reduce maintenance downtime...

Suitable for pumping and dosing low or high viscous, pasty, pure, neutral, aggressive or abrasive liquids, those containing gases or which tend to froth or those containing solids in the following industries: paint, dairy and beverage, meat and fish processing, pharmaceutical and cosmetics, waste water and water treatment, chemical and petrochemical industries, pulp and paper, textile, soap and fats, building, ceramics.

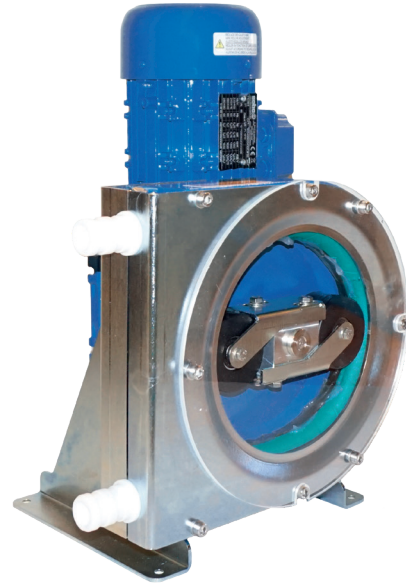

Operating data

Capacity:	up to 10 m ³ /h
Viscosity:	up to 15000 cps ***
Temperature of pumped liquid:	up to 135°C *
Differential pressure:	up to 4 bar **
Discharge pressure:	up to 4 bar
Achievable suction:	up to 0,6 bar ***

* At a room temperature of 20°C. Furthermore, it depends on the pumped fluid, on the hose quality and on the motor construction.

** It depends on the pump dimension and on the hose quality.

*** It depends on the pump dimension/execution, on the speed and on the tube material.

Flow table PTL pumps

[l/h]

TYPE	10 Rpm	20 Rpm	40 Rpm	60 Rpm	80 Rpm	100 Rpm	120 Rpm	140 Rpm
PTL09		20	40	60	80			
PTL13		49	98	167	196	245	294	344
PTL17		129	259	389	518	648	778	908

[m³/h]

TYPE	20 Rpm	40 Rpm	60 Rpm	80 Rpm	100 Rpm	120 Rpm	140 Rpm	160 Rpm
PTL25N	0,38	0,76	1,15	1,53	1,92	2,30	2,68	3,07
PTL30N	0,82	1,64	2,64	3,28	4,10	4,92	5,74	
PTL45N	2,30	4,61	6,92	9,23	11,5			



Continuous use



Intermittent use

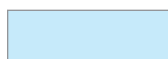

Occasional use
< 1 hour/day

Available drives

Gear motors or variable speed motors, both TEFC and explosion, electronic gear motor, inverters. Upon request, pneumatic drive units are available.

Available hoses materials & dimensions

Neoprene®, Hypalon, Silicone, NR, EPDM, NBR - foods Pharmed®

Without reinforcing: Hypalon; Norprene®; Silicone; Pharmed®

With polyamide reinforcing: Natural rubber (NR) ; NBR ; EPDM



® Pharmed Reg. Saint-Gobain Performance Plastics

Size	ID	OD	Lenght
PTL 09	9	16	330
PTL 13	13	22	390
PTL 17	17	31	590
PTL 25N	25	43	1150
PTL 30N	30	55	1150
PTL 45N	45	75	1455

Mineral	Hose Identification	Operating Temperatures	Industry Approvals	Available
Neoprene	Flat black color, rough surface, rubber smell	0 to 60°C		PTL09 - PTL25N
Norprene®	Off white, smooth surface	-35 to 135°C	USP Class VI	PTL09 - PTL45N
			FDA 21	
			CFR 177.2600	
			NSF listed (Standard 51)	
Silicone	Transparent, smooth surface or rust color	0 to 140°C		PTL09 - PTL25N
Pharmed®	Cream color, Pharmed* name on hose	-30 to 135°C	USP Class VI	PTL09 - PTL13
			FDA 21	
			CFR 177.2600	
			NSF listed (Standard 51)	
Hypalon	Black color, yellow stripe, double braided	0 to 90°C		PTL09 - PTL45N
EPDM Rubber	Black color, white stripe, double braided	0 to 90°C		
Natural Rubber	Black color, green stripe, double braided	0 to 80°C		
Nitrile Rubber	Black color	0 to 80°C		



TAPFLO PTL - Reliable Hose Pumps
 Exceptionally low shear, ensuring product quality,
 accurate and predictable performance
 with subsequent savings.

PT series

High pressure hose pumps

The latest design

PT pumps combine the best available materials with smart design solutions in order to maximise running time and minimise maintenance.

The PT series pump is an extremely reliable pump with a wide performance range, up to 150 m³/h and 15 bars, that can handle most fluids in most applications.

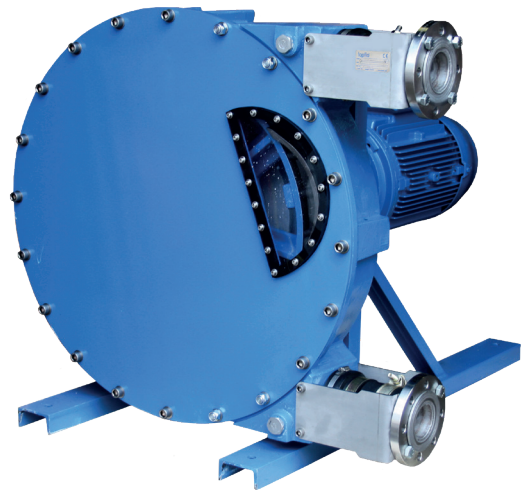

Operating data

Capacity:	up to 150 m ³ /h
Viscosity:	up to 100000 cps
Temperature of pumped liquid:	up to 135°C
Discharge pressure:	up to 15 bar
Self priming:	up to 9,8 m

Flow table PT pumps

[l/h]

TYPE	10 Rpm	20 Rpm	40 Rpm	60 Rpm	80 Rpm	100 Rpm	120 Rpm	140 Rpm
PT 05 (3 lobes)	3.4	6.8	13.6	20.4				
PT10 (3 lobes)	10	20	40	60				
PT 10	15	30	60	90	120	150	180	
PT 15	50	100	200	300	400	500	600	
PT 20	65	170	340	500	670	850	970	
PT 25	200	400	800	1 200	1 600	2 000	2 400	2 800
PT 32	375	750	1 500	2 250	3 000	3 750	4 500	5 250
PT 40	565	1 170	2 340	3 510	4 680	6 850	7 020	8 190
PTX 40	800	1 600	3 200	4 800	6 400	8 000		
PT 50	1750	3 500	7 000	10 500	14 000	17 500		
PT 65	2300	4 600	9 200	13 800	18 400	23 000		

[l/h]

TYPE	10 Rpm	20 Rpm	30 Rpm	35 Rpm	40 Rpm	45 Rpm	50 Rpm
PTX 80	5 500	11 000	16 500	19 250	22 000	24 750	27 500
PT 80	7 000	14 000	21 000	24 500	28 000	31 500	35 000
PT 100	12 000	24 000	36 000	42 000	48 000	54 000	
PT 125	22 000	44 000	66 000	77 000	88 000		



Continuous use



Intermittent use

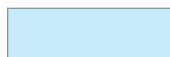







Occasional use < 1 hour/day

Available hoses materials

The PT series is designed to make hose changes quick and easy with no technical knowledge required. We only work with high quality compounded rubbers, reinforced with 2 to 6 individual layers of braided polyamide and with an outer layer made to strict tolerances to ensure perfect compression. The characteristics of Tapflo hoses enable them to last approximately 30% longer than other hoses on the market. They also fit the majority of other hose pumps.

For the hose inner layers, 6 materials are available to suit the diversity of the pumped fluids.

	white marking	double white marking	yellow marking	white & yellow marking	red marking	blue marking	purple marking
	NR (natural rubber)	NR FDA	NBR (buna)	NBR Food (approved FDA)	EPDM	HYPALON/CSM	VITON/FKM
							
Water treatment & Industrial waste	X	X	X		X	X	X
Ceramic industry	X				X		
Mining & quarries	X		X		X	X	X
Building & constructions	X		X		X		
Chemical	X		X		X	X	X
Food & beverage	X	X		X			
Paint	X				X		
Pulp & paper	X				X		
Agriculture, biogas	X	X	X		X	X	X

Pulsation dampener

In-line pulsation dampener will reduce vibration and water hammers in the piping therefore increasing the hose life.

Features & Benefits

- Pulsation reduction up to 90%
- Easy installation
- Few parts in contact with media



PT series - special versions

High pressure , high capacity

PTX 150

This pump has all the benefits of other peristaltic pumps, with the two key additional benefits of a much slower speed for a given flowrate; and rotating rollers for soft hose compression. These two features greatly increase hose life & reduce power consumption.



Example of applications

- » Effluent Processing
- » Mining Waste / Cake Transfer
- » Mud slurry Transfer
- » Sea Tanker Offloading
- » Sand Slurry Transfer
- » Fish boat doffloading

Features & Benefits

- ✓ No mechanical seal or stuffing box
- ✓ Reversible flow
- ✓ Damage-free continuous dry running
- ✓ Without lubricant
- ✓ Suitable for aggressive or viscous fluids
- ✓ Hoses available: NR and full EPDM

PTS series

Bare shaft execution

For customers who require a long shaft technology, Tapflo has also developed the PTS series.

These pumps are equipped with a removable bearing case for easy bearing maintenance and can be converted into a close coupling PT type pump at any time.

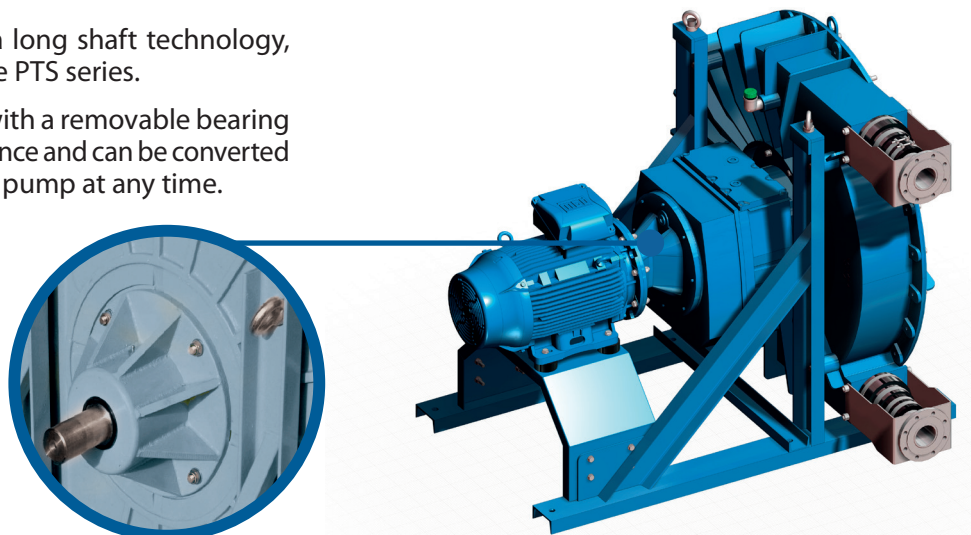

PT CIP

The revolutionary high pressure CLEAN IN PLACE

Tapflo as the leader of innovative peristaltic hose pump has developed a solution for easier and better clean in place hose pumps - A unique wheel to meet the requirements of its industrial customers from food, cosmetic and pharmaceutical industries.

The new PT CIP pump has a patent pending designed pump-wheel that will allow the pressing shoes to retract (not to compress the pump) for an efficient clean in place process.

Operating data

Capacity: from 0,5 up to 10 m³/h
Discharge pressure: up to 15 bar



PT pumps are available in "CIP wheel" (Clean In Place) option. It allows users, by simply reversing the direction of rotation of the pump (1/2 turn), to be able to retract the shoes automatically, in order to make the cleaning and sterilization operations, without any action on the pump. The client saves time and will keep the highest level of functionality in the process.

Features & Benefits

- ✓ Seal-less design
- ✓ Can run dry without damage
- ✓ Does not damage or shear the pumped fluid while maintaining a high level of hygiene
- ✓ A maximum amount of function and production time
- ✓ Min. use of moving parts and requires a min. amount of maintenance
- ✓ Only the inner part of the hose is in contact with the pumped fluid

Available hoses materials

Tapflo can offer food grade hoses in **EPDM FDA**, **NBR FDA** and **NR FDA** and meet the certifications EC 1935/2004 and FDA CFR21§177.2600.

The internal of the hose is white (**NR FDA** and **EPDM FDA**) or black (**NBR FDA**), according to the pumped fluid.

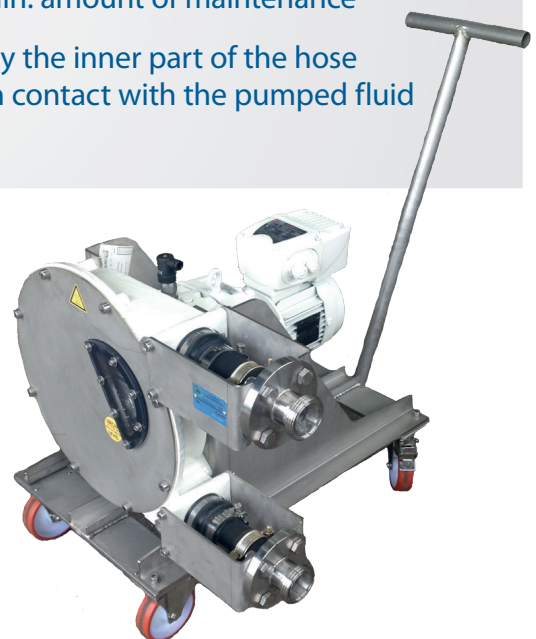

Product range

Diaphragm pumps & accessories

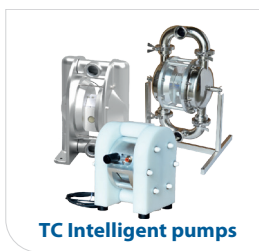

Peristaltic Pumps



Centrifugal pumps, filter units & accessories



United Kingdom

Tel: 02380 252325

Email: sales@tapflopumps.co.uk

E-mail addresses:

Commercial questions: sales@tapflo.com

Orders: order@tapflo.com

Tech support: support@tapflo.com

Tapflo products and services are available in 75 countries on 6 continents.

Tapflo is represented worldwide by own Tapflo Group Companies and carefully selected distributors assuring highest Tapflo service quality for our customers' convenience.

AUSTRALIA | AUSTRIA | AZERBAIJAN | BAHRAIN | BELARUS | BELGIUM | BOSNIA | BRAZIL | BULGARIA | CANADA | CHILE | CHINA | COLOMBIA | CROATIA | CZECH REPUBLIC | DENMARK | ECUADOR | EGYPT | ESTONIA | FINLAND | FRANCE | GREECE | GEORGIA | GERMANY | HONG-KONG | HUNGARY | ICELAND | INDIA | INDONESIA | IRAN | IRELAND | ISRAEL | ITALY | JAPAN | JORDAN | KAZAKHSTAN | KUWAIT | LATVIA | LIBYA | LITHUANIA | MACEDONIA | MALAYSIA | MEXICO | MONTENEGRO | MOROCCO | NETHERLANDS | NEW ZEALAND | NORWAY | POLAND | PORTUGAL | PHILIPPINES | QATAR | ROMANIA | RUSSIA | SAUDI ARABIA | SERBIA | SINGAPORE | SLOVAKIA | SLOVENIA | SOUTH AFRICA | SOUTH KOREA | SPAIN | SUDAN | SWEDEN | SWITZERLAND | SYRIA | TAIWAN | THAILAND | TURKEY | UKRAINE | UNITED ARAB EMIRATES | UNITED KINGDOM | USA | UZBEKISTAN | VIETNAM

Tapflo Group Companies

Australia

Tapflo Oceania (Pty) Ltd
Tel: +61 1800 303 633
sales@tapflo.com.au

Austria

Tapflo Austria
Tel: +43 732 27292910
sales@tapflo.at

Baltic States

Tapflo Latvia
Tel: +371 67472205
sales@tapflo.lv

Belarus

Tapflo Belarus
Tel: +375 17 3934609
sales@tapflo.by

Belgium

Tapflo Benelux B.V.
Tel: +31 (0)85 00 743 00
info@tapflo.nl

Bulgaria

Tapflo EOOD
Tel: +359 (0)2 974 18 54
office@tapflo.bg

Canada

Tapflo Canada
Tel: +1 514 813 5754
canada@tapflo.com

Croatia

Tapflo d.o.o.
Tel: +385 91 4884 666
sales@tapflo.hr

Czech Republic

Tapflo s.r.o.
Tel: +420 513 033 924
tapflo@tapflo.cz

China

Tapflo (Wuxi)
Tel: +86 510 8241 7072
sales@tapflo.cn

Denmark

Tapflo Danmark
Tel: +45 36 454600
info@tapflo.dk

France

Tapflo France
Tel: +33 1 34 78 82 40
info@tapflo.fr

Hungary

Tapflo kft.
Tel: +36 30 148 8551
office@tapflo.hu

India

Tapflo Fluid Handling India Pvt Ltd
Tel: +91 20 65000215
ac@tapflo.in

Ireland

Tapflo Ireland Ltd
Tel: +353 1 2011911
info@tapflo.ie

Italy

Tapflo Italia
Tel: +39 0362 306528
info@tapfloitalia.com

Japan

Tapflo Japan K.K.
Tel: +81-3-6240-3510
tapflojp@tapflo.co.jp

Kazakhstan

Tapflo Kazakstan
Tel: +7 727 3278347
sales@tapflo.kz

Netherlands

Tapflo Benelux B.V.
Tel: +31 (0)85 00 743 00
info@tapflo.nl

Poland

Tapflo Sp. z o.o.
Tel: +48 58 530 42 12
info@tapflo.pl

Romania

S.C. Tapflo Rom. S.r.l.
Tel: +40 21 3451255
sales@tapflo.ro

Russia

Tapflo Company
Tel: +7 495 232 18 28
sales@tapflo.com.ru

Serbia

Tapflo d.o.o.
Tel: +381 21 44 58 08
sales@tapflo.rs

Slovakia

Tapflo s.r.o.
Tel: +421 911 137 883
tapflo@tapflo.sk

Slovenia

Tapflo GmbH
Tel: +386 68 613 474
sales@tapflo.hr

Spain

Tapflo Iberica
Tel: +34 91 8093182
avives@tapfloiberica.es

South Africa

Tapflo (Pty) Ltd
Tel: +27 31 701 5255
sales@tapflo.co.za

Turkey

Tapflo Makina Ltd
Tel: +90 216 467 33 11
sales@tapflo.com.tr

Ukraine

TOB Tapflo
Tel: +380 44 222 68 44
sales@tapflo.ua

Uzbekistan

Tapflo Uzbekistan
Tel: +998 712370940
sales@tapflo.uz

United Kingdom

Tapflo (UK) Ltd
Tel: +44 2380 252325
sales@tapflopumps.co.uk



If your country is not listed
please visit
www.tapflo.com/en/contact